

PT430/PT430F

Narrow Acceptance *T-41-61*
Phototransistor

■ Features

1. Narrow acceptance epoxy resin package ($\Delta\theta$: TYP. $\pm 13^\circ$)
2. Visible light cut-off type : PT430F

■ Applications

1. VCRs, cassette tape recorders
2. Optoelectronic switches, optoelectronic counters
3. Automatic stroboscopes

■ Outline Dimensions

(Unit : mm)

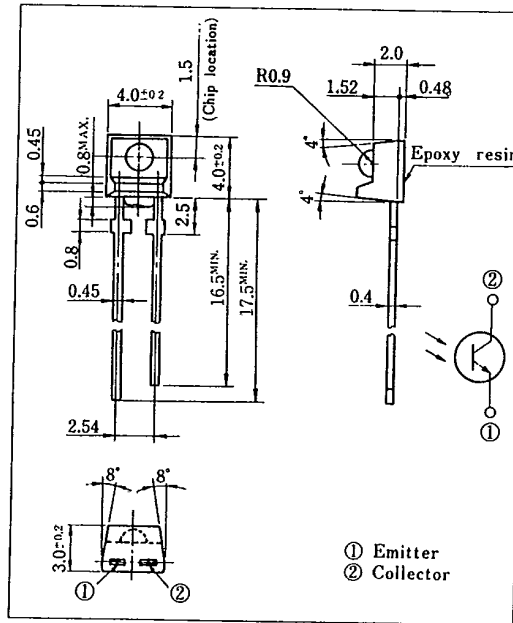

■ Absolute Maximum Ratings

($T_a = 25^\circ\text{C}$)

Parameter	Symbol	Rating	Unit
Collector-emitter voltage	V_{CE0}	35	V
Emitter-collector voltage	V_{ECO}	6	V
Collector current	I_C	20	mA
Collector power dissipation	P_C	75	mW
Operating temperature	T_{opr}	$-25 \sim +85$	$^\circ\text{C}$
Storage temperature	T_{stg}	$-40 \sim +85$	$^\circ\text{C}$
*1 Soldering temperature	T_{sol}	260	$^\circ\text{C}$

*1 For 3 seconds at the position of 2.5mm from the bottom face of resin package

■ Electro-optical Characteristics

($T_a = 25^\circ\text{C}$)

Parameter	Symbol	Conditions	MIN.	TYP.	MAX.	Unit
*2 Collector current	PT430	$V_{CE} = 5V$ $E_e = 1mW/cm^2$	0.4	1.7	6.0	mA
	PT430F		0.25	0.8	3.0	mA
Collector dark current	I_{CE0}	$V_{CE} = 20V, E_e = 0$	—	10^{-9}	10^{-7}	A
*2 Collector-emitter saturation voltage	$V_{CE(sat)}$	$I_C = 0.5mA, E_e = 10mW/cm^2$	—	0.1	0.4	V
Peak sensitivity wavelength	PT430		—	800	—	nm
	PT430F		—	860	—	nm
Response time (Rise)	t_r	$V_{CE} = 2V, I_C = 2mA, R_L = 100\Omega$	—	3	—	μs
Response time (Fall)	t_f		—	3.5	—	μs

*2 E_e : Irradiance by CIE standard light source A (tungsten lamp)

T-41-61

Fig. 1 Collector Power Dissipation vs. Ambient Temperature

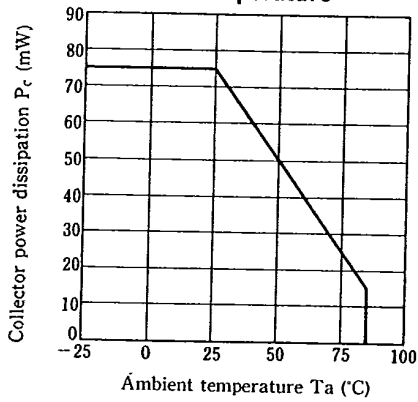

Fig. 2 Collector Dark Current vs. Ambient Temperature

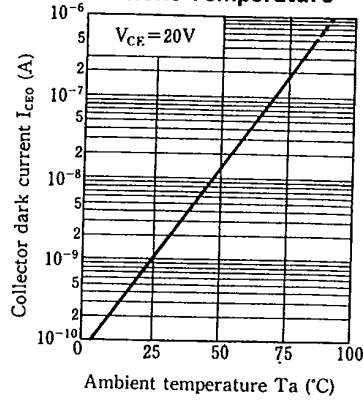

Fig. 3 Relative Collector Current vs. Ambient Temperature

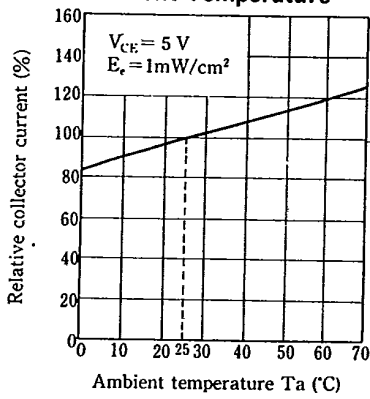
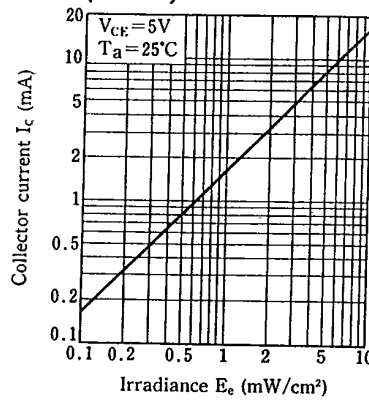

Fig. 4 Collector Current vs. Irradiance (PT430)



5

Fig. 5 Collector Current vs. Irradiance (PT430F)

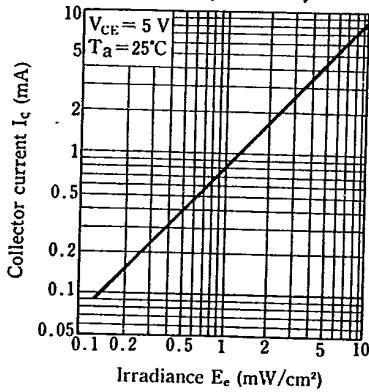

Fig. 6 Collector Current vs. Collector-emitter Voltage (PT430)

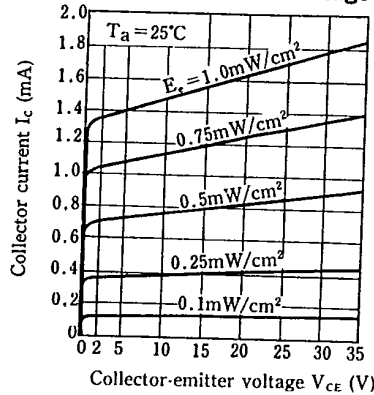

Fig. 7 Collector Current vs. Collector-emitter Voltage (PT430F)

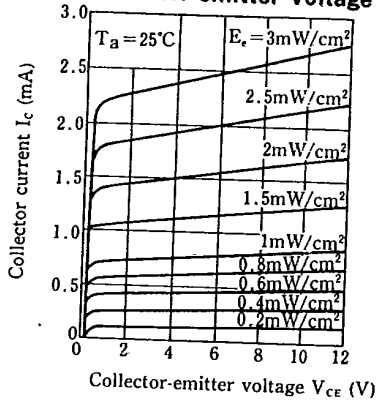

Fig. 8 Spectral Sensitivity (PT430)

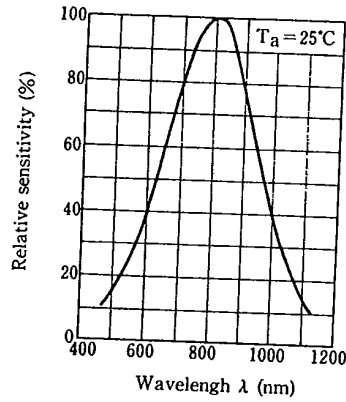

Fig. 9 Spectral Sensitivity (PT430F)

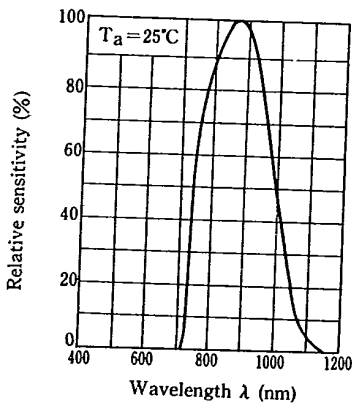
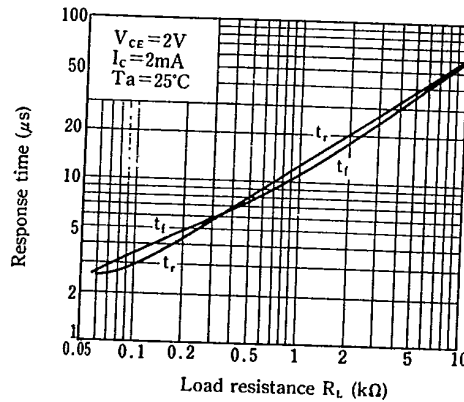

Fig. 10 Response Time vs. Load Resistance



Test Circuit for Response Time

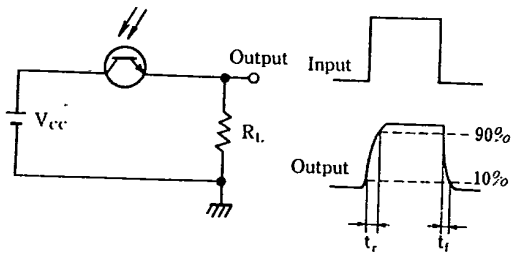

Fig. 11 Sensitivity Diagram

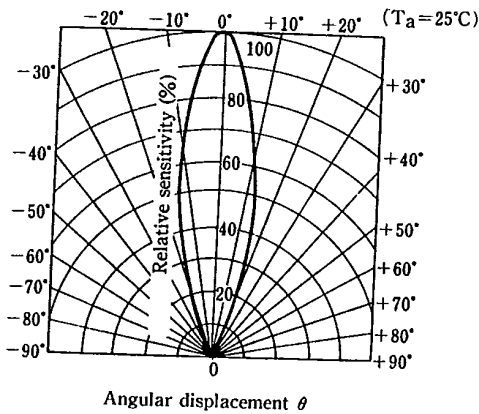

Fig. 12 Collector-emitter Saturation Voltage vs. Irradiance (PT430)

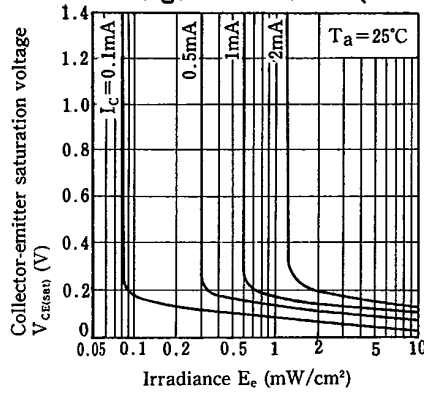

Fig. 13 Collector-emitter Saturation Voltage vs. Irradiance (PT430F)

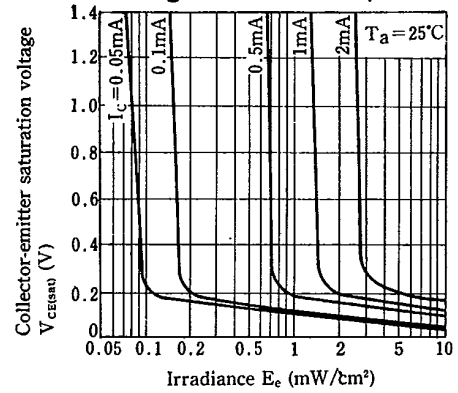

Fig. 14 Relative Output vs. Distance (Emitter : (GL430))

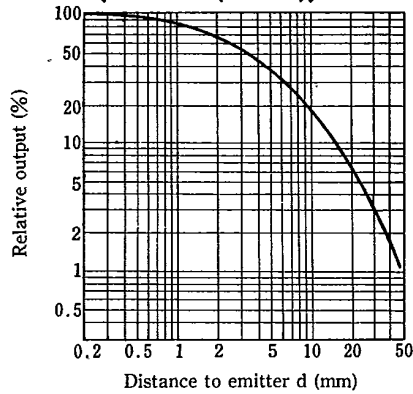
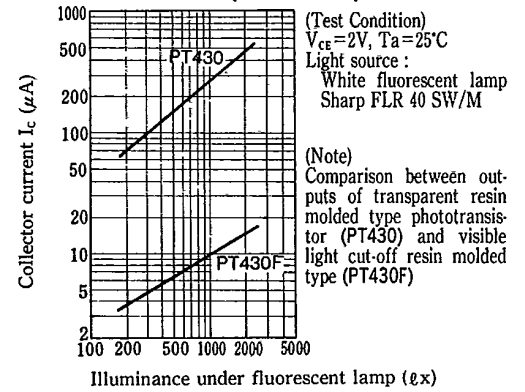

Fig. 15 Collector Current vs. Illuminance (Reference)



5